

Dalton



	Seduta - Seat	Schienali - Backrests	Struttura - Structure	
Rivestimento Upholstering (10)	Sfoderabile / Removable 	Sfoderabile / Removable 	Sfoderabile / Removable 	
	Non sfoderabile / Not removable -	Non sfoderabile / Not removable -	Non sfoderabile / Not removable 	
Imbottiture Padding (2-4-5-6-7-8)				 Optional

INFORMAZIONI TECNICHE

Struttura: 1-3

Struttura base in particelle di legno (MDF) classe E1. Masselli portanti in legno di abete. Elementi strutturali in pannelli di legno multistrati in classe E1 e pannelli di particelle di legno in classe E1, tamponamenti in faesite.

Molleggio: 1-11

Schienale in pannello di faesite. Seduta in pannello di particelle di legno.

Note:

Con i piedi UP l'intero divano o composizione possono essere alzati di 5cm rispetto alle dimensioni riportate.

TECHNICAL INFORMATION

Structure: 1-3

Frame structure in wood particles (MDF) class E1. Solid fir wood. Structural elements in multilayer wood panels in class E1 and panels of wood particles in class E1, infills in faesite.

Springing: 1-11

The back is made of hardboard panels. Particleboard wooden panels seat base.

Note:

With UP feet the whole sofa or composition can be raised 5 cm compared to the dimensions shown.

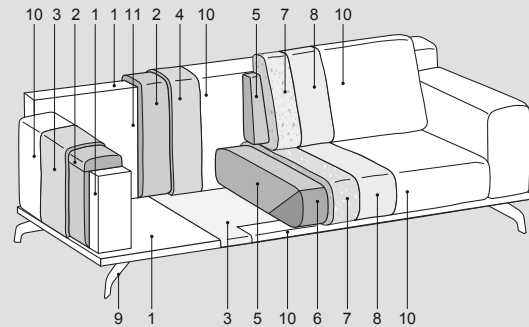
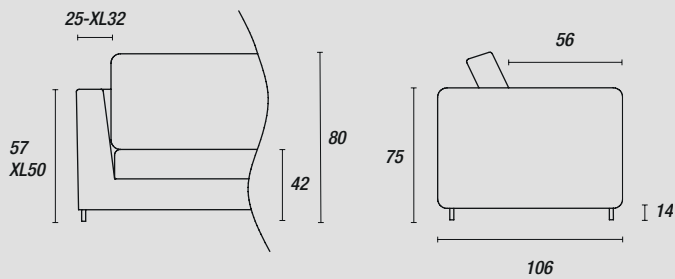



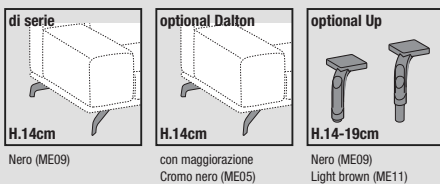





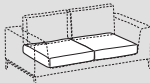
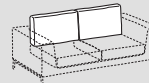
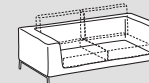

Piedini - Feet:



Dalton soft



	 Seduta - Seat	 Schienali - Backrests	 Struttura - Structure	
Rivestimento Upholstering (10)	Sfoderabile Removable  	Sfoderabile Removable  	Sfoderabile Removable  	
	Non sfoderabile Not removable -	Non sfoderabile Not removable -	Non sfoderabile Not removable -	
Imbottiture Padding (2-4-5-6-7-8)	 D.35/40kg/m³	 Misto piuma	 Pol.espanso Tecnoform	 Optional

INFORMAZIONI TECNICHE

Struttura: 1-3

Struttura base in particelle di legno (MDF) classe E1. Masselli portanti in legno di abete. Elementi strutturali in pannelli di legno multistrati in classe E1 e pannelli di particelle di legno in classe E1, tamponamenti in faesite.

Molleggio: 1-11

Schienale in pannello di faesite.
Seduta in pannello di particelle di legno.

Note:

Con i piedi UP l'intero divano o composizione possono essere alzati di 5cm rispetto alle dimensioni riportate.

TECHNICAL INFORMATION

Structure: 1-3

Frame structure in wood particles (MDF) class E1. Solid fir wood. Structural elements in multilayer wood panels in class E1 and panels of wood particles in class E1, infills in faesite.

Springing: 1-11



The back is made of hardboard panels.
Particleboard wooden panels seat base.

Note:

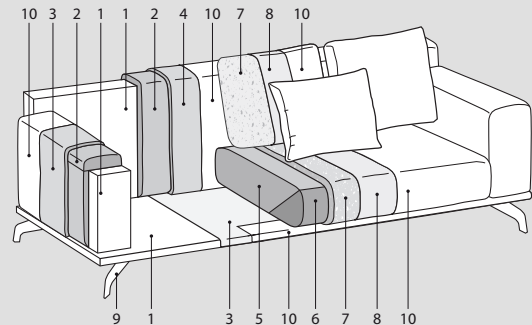
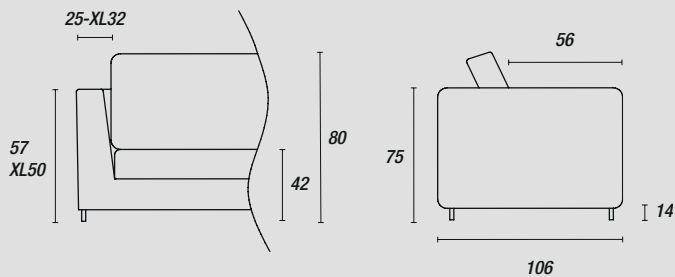
With UP feet the whole sofa or composition can be raised 5 cm compared to the dimensions shown.

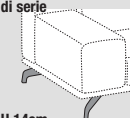
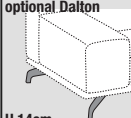

Piedini - Feet:

 di serie H.14cm Nero (ME09)	 optional Dalton H.14cm con maggiorazione Cromo nero (ME05)	 optional Up H.14-19cm Nero (ME09) Light brown (ME11)
--	--	--